

SINGLE T

CORNER □

NICHE solo □

NICHE duo □

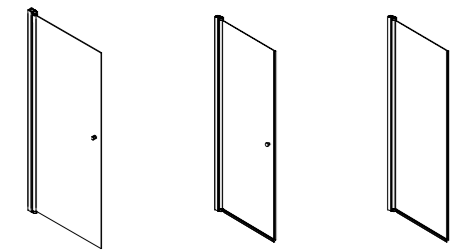

FORM door MODE SOLA

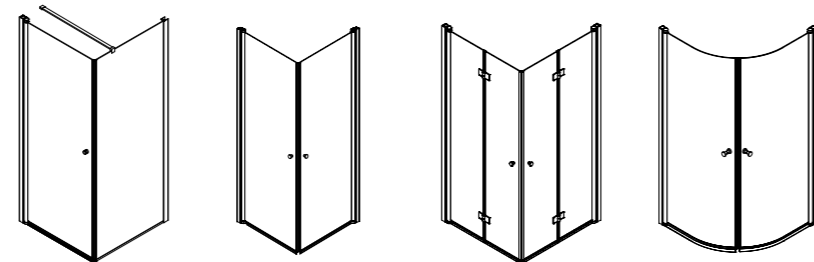

FORM MODE FOLD ARC



FORM door

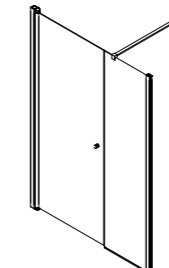

FORM

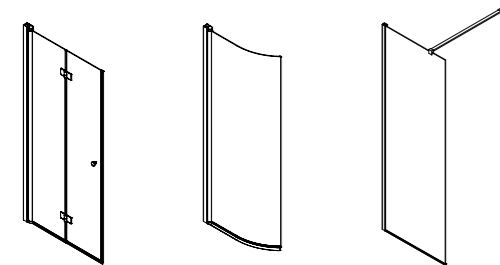

FOLD AXIS LINE, EXTRALINE

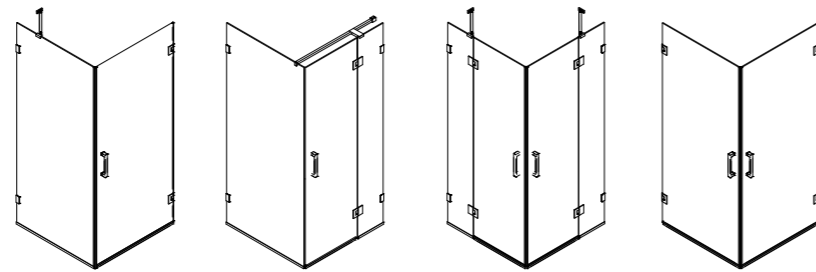

CONCEPT 1 CONCEPT 2 CONCEPT 3 CONCEPT 4



FOLD

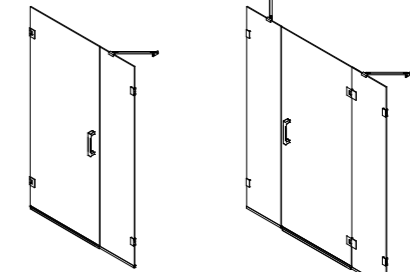

CONCEPT 6 CONCEPT 8 CONCEPT 11

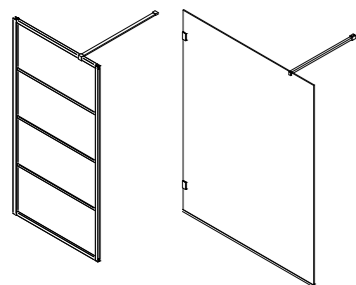

FRAMELINE CONCEPT 13

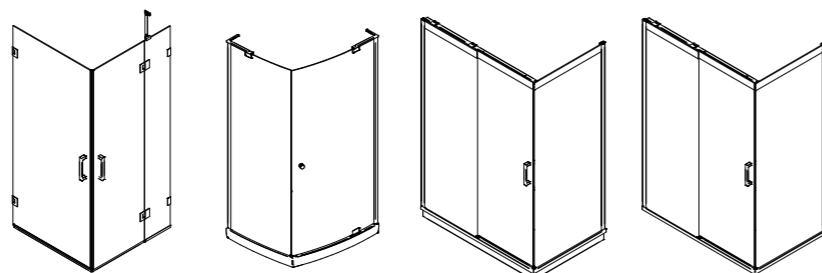

CONCEPT 5 VIBE (with tray) MAKRO (with tray) MAKRO (without tray)

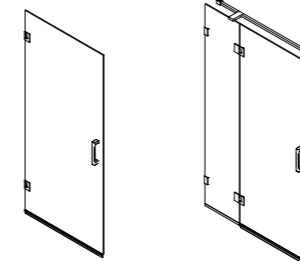

CONCEPT 7 CONCEPT 9

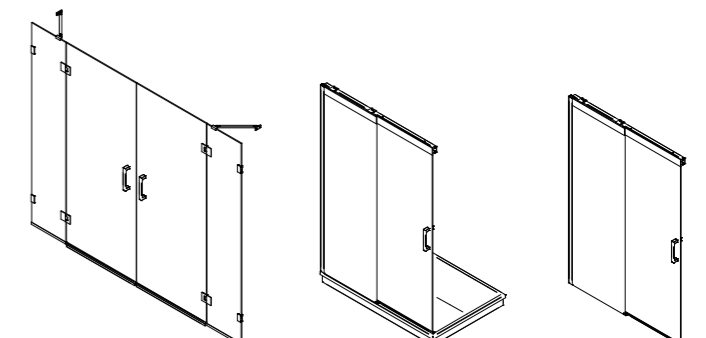

CONCEPT 10 MAKRO (with tray) MAKRO (without tray)